

Article number: 203502582244NI

Description: E+G Levelling sets GN 350.2-58-22-44-NI

Measures

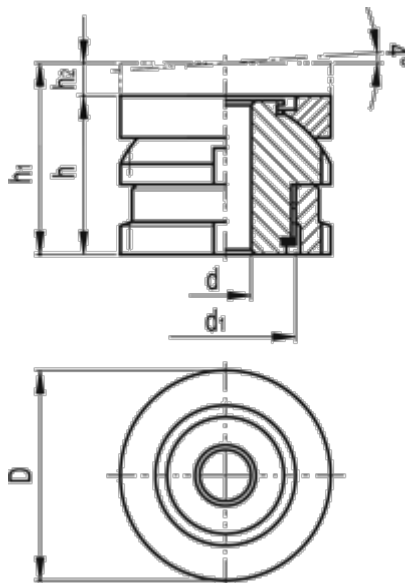

C-spanner DIN 1810 = A58-62

d = 22

D = 58

d_1 = M40x1.5

For screw = M20

h = 44

h_1 = 53

h_2 = 9

Max static load (kN) = 148

Static preload (kN) = 59.08

Weight (g) = 610